

TAGA[®]

HARMONY

To Achieve Glorious Acoustics

Platinum IW LCRS / TCI Platinum SE / TCI Platinum / GTCS / RB / TCW / TLCR Series

IN-WALL / IN-CEILING SPEAKERS



Instruction Manual

Introduction

Thank you for purchasing TAGA Harmony Speakers.

TAGA Harmony installation speakers provide superior sound performance and amazing value. They utilize very stiff and strong cabinets, which minimize distortion, vibrations or resonances and specialized mounting brackets that make installation very easy.

All speakers are designed to be used both in music and home theatre systems in any area of your home or commercial applications. The sound is clear, natural, dynamic and provides wide dispersion throughout a listening area, without occupying your valuable floor space!

The frames and grills may be painted to blend with any decor.

This instruction manual provides all of the information that you need to know about your TAGA Harmony Speakers. Please read it carefully before you start using the unit.

Cleaning

Do not use strong or abrasive cleaners. Use a damp, soft cloth for cleaning. Do not get any part of the speaker wet.

Specifications

Full technical specifications are available on the www.TagaHarmony.com website.

Contents

Speaker Placement	3
Hooking Up the Wires	7
Speaker Mounting	8
Additional Features	10
Painting	11
Installing the Grill	11

Speaker Placement

Please spend some time considering placement prior to installing the speaker. Once it is installed, it is not to be easily moved or repositioned. Each room has its specific acoustics but there are some general rules:

Location

TAGA Harmony speakers can be installed almost anywhere thanks to our unique sound characteristic which is strong and powerful, and has a wide dispersion field.

General notes

In-wall	In-ceiling
Placing the speakers near a corner will tend to increase their bass output, but may result in “boomy” or “muddy” sound.	Corner placement close to the walls provides a good balance of bass output and accuracy.
Placing the speakers further into the room will tend to decrease their bass output, but may result in improved articulation and clarity.	
Place the speakers at least 60 cm (2 feet) away from corners and other surfaces which may interfere or reflect sound (like tall furniture).	
To add extra bass and definition to your system we recommend TAGA Harmony Custom Installations or traditional subwoofers.	

Placement for critical listening in stereo (2 speakers)

In-wall	In-ceiling
Place the front left and right speakers at an equal distance from your listening position, at ear level while seated.	Place the left and right speakers at an equal distance from your listening position. Aim the speaker toward your listening position (if your speakers have this feature).
If the speakers are installed in a wall which is around 300 cm (10 feet) away from your listening position, place them no more than 300 cm (10 feet) apart from each other and no less than 150 cm (5 feet).	Place the speakers no more than 300 cm (10 feet) apart from each other and no less than 150 cm (5 feet).

Placement for entertainment listening or background music (1 or more speakers)

In-wall	In-ceiling
In rectangular smaller rooms [below 30 square meters (320 square feet)] usually 1 or 2 speakers should work fine. If you use 2 – place them near opposite corners. If you use 1 – place it on the most empty and biggest wall.	In rectangular smaller rooms [below 30 square meters (320 square feet)] usually 1 or 2 speakers should work fine. If you use 2 – place them near opposite corners. If you use 1 – place it in the center.
In irregular or larger rooms use more than 2 speakers and place them evenly across the space for good sound dispersion.	

Speaker Placement

Placement for Home Theatre

(the pictures shown for the listening position in the middle of the room)

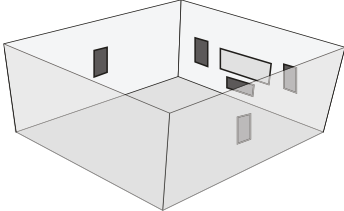
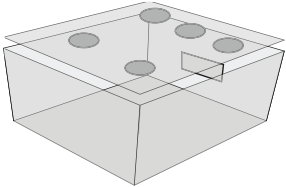
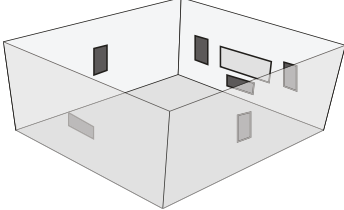
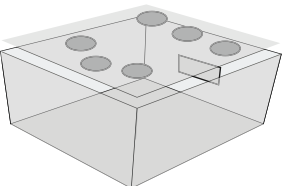
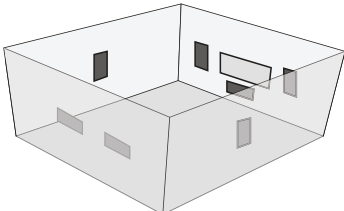
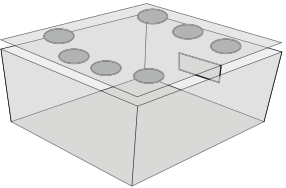
On-wall	On-ceiling
<p data-bbox="266 288 421 312">5.0/5.1 Systems</p>  <p>A 3D perspective diagram of a room showing speaker placement for a 5.0/5.1 system. The front wall has a large central speaker and two smaller side speakers. The side walls each have one speaker. The back wall has a subwoofer. The listening position is in the center of the room.</p>	<p data-bbox="729 288 883 312">5.0/5.1 Systems</p>  <p>A 3D perspective diagram of a room showing speaker placement for a 5.0/5.1 system with speakers on the ceiling. The front wall has a large central speaker and two smaller side speakers. The side walls each have one speaker. The back wall has a subwoofer. The listening position is in the center of the room.</p>
<p data-bbox="266 544 421 568">6.0/6.1 Systems</p>  <p>A 3D perspective diagram of a room showing speaker placement for a 6.0/6.1 system. The front wall has a large central speaker and two smaller side speakers. The side walls each have one speaker. The back wall has a subwoofer. The listening position is in the center of the room.</p>	<p data-bbox="729 544 883 568">6.0/6.1 Systems</p>  <p>A 3D perspective diagram of a room showing speaker placement for a 6.0/6.1 system with speakers on the ceiling. The front wall has a large central speaker and two smaller side speakers. The side walls each have one speaker. The back wall has a subwoofer. The listening position is in the center of the room.</p>
<p data-bbox="266 805 421 829">7.0/7.1 Systems</p>  <p>A 3D perspective diagram of a room showing speaker placement for a 7.0/7.1 system. The front wall has a large central speaker and two smaller side speakers. The side walls each have one speaker. The back wall has a subwoofer. The listening position is in the center of the room.</p>	<p data-bbox="729 805 883 829">7.0/7.1 Systems</p>  <p>A 3D perspective diagram of a room showing speaker placement for a 7.0/7.1 system with speakers on the ceiling. The front wall has a large central speaker and two smaller side speakers. The side walls each have one speaker. The back wall has a subwoofer. The listening position is in the center of the room.</p>

Speaker Placement

In-wall	In-ceiling
<p>Front speakers</p> <p>Place the left and right speakers at an equal distance from your listening position, slightly above ear level while seated.</p> <p>If the speakers are installed in a wall which is around 300 cm (10 feet) away from your listening position, place them no more than 300 cm (10 feet) apart from each other and no less than 150 cm (5 feet).</p>	<p>Front speakers</p> <p>Place the left and right speakers at an equal distance from your listening position, in front of your TV and about 60 – 90 cm (2 – 3 feet) away from the wall.</p> <p>Aim the tweeters towards the listening position (if your speakers have this feature).</p> <p>If the speakers are installed around 300 cm (10 feet) away from your listening position, place them no more than 300 cm (10 feet) apart from each other and no less than 150 cm (5 feet).</p>
<p>Center speaker</p> <p>Place the speaker at ear level while seated. If you have a TV mounted on wall, place the speaker slightly below it. If you have a TV on a table, place the speaker above it and angle the tweeter down towards ear level while seated (if your speaker has this feature).</p> <p>6.0/6.1 systems – place the second center speaker (rear center) on the opposite wall to the first one – at the same height and angle the tweeter down towards ear level while seated (if your speaker has this feature).</p>	<p>Center speaker</p> <p>Place the speaker in the middle of the front left and right speakers. Aim the tweeters towards the listening position (if your speaker has this feature).</p> <p>6.0/6.1 systems – place the second center speaker (rear center) behind your listening position, in line with the front center speaker.</p>
<p>Surround speakers</p> <p>Place the speakers above ear level while seated, but no higher than ear level while standing.</p> <p>5.0/5.1/6.0/6.1 systems – place the right and left surround on the right and left side of your listening position.</p> <p>7.0/7.1 systems – place the right and left surround on the right and left side of your listening position. The two additional rear surround speakers should be placed behind your listening position. They should be placed at equal distances from your listening position, and about half as far as the right and left surrounds. All four surrounds should be mounted at the same height.</p>	<p>Surround speakers</p> <p>5.0/5.1/6.0/6.1/7.0/7.1 systems – place the right and left surround on the right and left side of your listening position, as far apart as your front left and right speakers.</p> <p>7.0/7.1 systems – place the rear right and left surrounds behind your listening position, at equal distances from your position. They should be about half as far apart as the right and left surround speakers positioned on the sides.</p>
<p>We recommend to use TAGA Harmony in-wall/in-ceiling or traditional subwoofer in all Home Theatre systems.</p>	

Speaker Placement

Placement for Stereo/Mono models

TAGA Harmony Stereo/Mono models offer wider sound dispersion than regular speakers.

STEREO CONNECTION	MONO CONNECTION
<p style="text-align: center;">Single speaker</p> <p>In smaller areas where a stereo pair of speakers cannot be used or where a single speaker is preferred to be used.</p> <p>7.0/7.1 systems – use the speaker as rear center speaker. Position tweeters towards the left and right sides of the room.</p>	<p style="text-align: center;">Single speaker</p> <p>6.0/6.1 systems – use the speaker as rear center speaker. Position tweeters towards the left and right sides of the room.</p>
<p style="text-align: center;">Multiple speakers</p> <p>In larger areas to eliminate the sound imbalances and offer better sound coverage.</p> <p>7.0/7.1 systems – use two speakers as surround speakers. Position one tweeter of each speaker towards the front side of the room and the other tweeter towards the back side.</p>	<p style="text-align: center;">Multiple speakers</p> <p>5.0/5.1 systems – use two speakers as surround speakers. Position one tweeter of each speaker towards the front side of the room and the other tweeter towards the back side.</p>

Placement of Platinum IW LCRS and TLCR Series

TAGA Harmony Platinum IW LCRS and TLCR speakers can be used in stereo, entertainment and background music applications as well as front, center and surround speakers.

Hooking Up the Wires

The speaker terminal can accommodate up to 10 AWG speaker cables (selected models only - others up to 14 AWG). 10 or 14 AWG speaker cables are recommended for longer connections (greater than 20 meters / 66 feet). For shorter lengths you can use 16 or 18 AWG speaker cables. It is recommended to leave about 150 cm (5 feet) of extra cable at the speaker end to facilitate positioning and installation of the speaker. Do not use staples, nails or other metal objects to secure the speaker cables. You will get the best sound quality and least amount of hum by keeping the speaker cables away from other electrical wires and cables.

Pay attention to connecting the polarity of the speaker correctly with the amplifier speakers output terminals (RED + with RED +, BLACK - with BLACK -). Before connecting the speaker make sure that your amplifier is switched off. Please refer to your amplifier's instruction manual for more information.

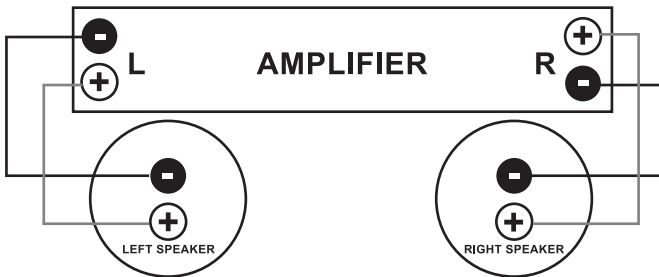

WARNING! Check whether your amplifier may work with impedance of your TAGA Harmony speaker. Otherwise you may burn the amplifier and damage the speakers - it may void your warranty.

Stereo/Mono Models

STEREO CONNECTION	MONO CONNECTION
<p>Connect a single speaker to two amplifier speakers output terminals.</p> <p>Connect one amplifier speakers output terminal with one speaker input terminal (RED + with RED +, BLACK - with BLACK -), connect the other amplifier speakers output terminal with the other speaker input terminal (RED + with RED +, BLACK - with BLACK -).</p>	<p>Connect a single speaker to a single amplifier speakers output terminal.</p> <p>Connect one amplifier speakers output terminal with one speaker input terminal (RED + with RED +, BLACK - with BLACK -). Using a short piece of speaker cable connect Left + (RED) speaker input terminal with Right + (RED) speaker terminal. Do the same for - terminals (BLACK).</p>

Speaker Mounting

The below mounting procedure applies to drywall walls, drywall ceilings and drop ceilings or similar.

You will have to cut a hole in a wall or ceiling. With the right tools and a little extra care and preparation, installing the speaker can be both quick and easy.

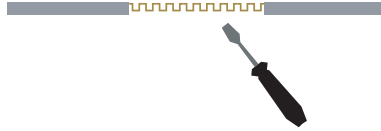

There are 2 types of paper templates which are helpful to cut out a hole for installing the speaker.

Your speaker is supplied with one of the templates.

- **Type #1** a template is drawn on a cardboard sheet and you have cut out a hole along the drawn lines.
- Carefully cut out hole drawn on the cardboard template.
- Position the template in place you wish to mount the speaker, and draw a line on the wall or ceiling along the inside edge of the template.
- **Type #2** is a cardboard template which has the shape of a hole which has to be cut out.
- Position the template in place you wish to mount the speaker, and draw a line on the wall or ceiling along the outside edge of the template.
- Make your cuts along the line in the wall or ceiling. Try to keep the cuts neat, however the frame of the speaker will overlap the hole to hide any rough edges.
- Run the speaker cables leaving about 150cm (5 feet) of extra cable at the hole.
- Connect the speaker cable to the speaker terminals.

Models equipped with the screw type clamps

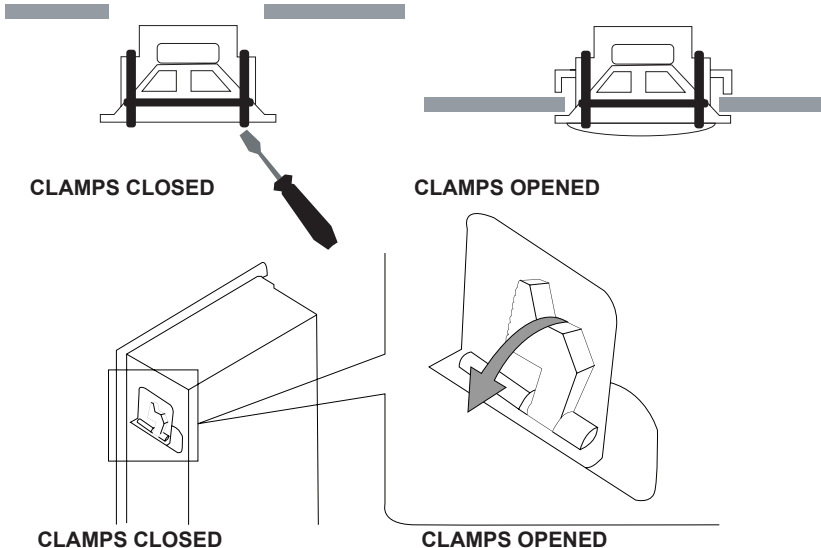

Speaker Mounting

- Remove the speaker grill by pressing the mounting screws from the back of the speaker or in case when your speaker is equipped with a magnetic grill gently pull it out.
- Make sure that the clamps are in their initial position and do not protrude beyond the outline of the speaker.
- With grill removed, insert the speaker into the mounting hole.
- Use a screwdriver to turn the clamps mounting screws to open each clamp fully.
- The cut edges of the wall or ceiling will be sandwiched firmly between the mounting clamps and the speaker frame.

Models equipped with the spring clamp mechanism

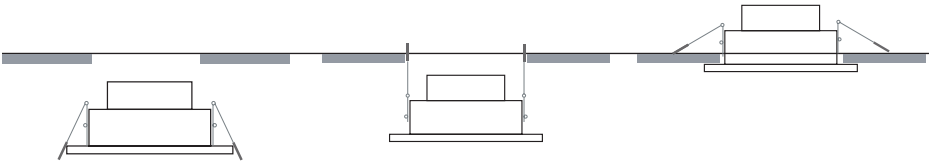

- Press and hold the spring clamps in the upward position.
- While holding insert the speaker into the mounting hole.
- After inserting the spring clamps will automatically fall down to secure the speaker in the hole.

Additional Features

Selected model are equipped with some of the following features:

- **Magnetically mounted grill** - easy to put on and take off. Make sure not to place any objects between the grill and the speaker frame with mounted magnets.
- **Swivel tweeter** - depending on your particular primary listening area, room acoustics, ceiling height, or personal preference, you may find the sound more pleasing by pointing the tweeter in a particular direction. If additional treble is desired in the primary listening area, point the tweeter towards that area; and if less treble is required, point tweeter away.
Push gently at the edge of the tweeter to point it in the desired direction.
- **+/- 3dB Environmental Equalizer (treble switch)** to compensate speaker positioning and room anomalies.
Switch positions:
 - + 3dB (+ or top position depending on a model): the tweeter will play 3dB higher.
 - 0 (center position): tweeter will play in the most linear frequency response.
 - 3dB (- or bottom position depending on a model): the tweeter will play 3dB lower.

Painting

In the selected models the grille and the frame, may be painted to match your room decoration.

If you want to paint the speaker frame use the part of the template remaining after the hole has been cut out. With the grille removed, protect the speaker with this part and paint the frame.

When painting the grille, make sure to remove the protective internal fabric (if your speaker is equipped with it) and to not plug the grille holes with paint or repaint it after the paint has dried. If your speaker was equipped with the protective internal fabric make sure to place it on the grille after the paint has dried.

Installing the Grill

Before installing the grill run your amplifier and check whether there are no vibrations audible from the speaker. If you hear any, it may be caused by the loose screws - tighten them up.

Install the grill and enjoy the music and movies!

We strongly advise to contact a professional installer or dealer in order to install TAGA Harmony products.

We recommend using high quality TAGA Harmony cables and other installation accessories.



Your product is marked with the symbol as showed on the left.
For EU (European Union) member users:
This product has been tested and found in compliance with requirements of the European Community 2014/30/EU (EMC).



IMPORTANT!

Your product is marked with the symbol as showed on the left.
For EU (European Union) member users:

According to the WEEE (Waste electrical and electronic equipment) Directive, do not dispose of this product as household waste or commercial waste. Waste electrical and electronic equipment should be appropriately collected and recycled as required by practices established for your country. For information on recycling of this product, please contact your local authorities, your household waste disposal service or the shop where you purchased the product.

TAGA EUROPE
POLPAK POLAND Sp. z o.o.
AL.JEROZOLIMSKIE 333A
05-816 REGULY k/WARSZAWY, POLAND
Email: sales@tagaharmony.com

www.Tagaharmony.com